

Product Specification

Product name: Molded Case Circuit Breaker (MCCB)

Product model: NDM2-63

Date: 20111109

Prepared by	Reviewed by	Approved by
Zhang Ying	Wu Chunyan	Li Shengai

Nader 良信电器	Document name	Product Specification	Document No.	NDT500137
	Product model and name	NDM2-63 Molded Case Circuit Breaker	Version	1
			Implementation date	20111109

Revision History

Version	Revision Content	Revision Date	Revised by
0	New addition	20111109	Zhang Ying
1	Product appearance change	20160420	Zhang Pan

Document No.	NDT500137	Version	1	Implementation date	20111109
--------------	-----------	---------	---	---------------------	----------

NDM2-63

1、 Application Scope and Purpose

NDM2 series of molded case circuit breakers (referred to as circuit breakers) apply to infrequent switching of circuits with the 50/60Hz, the rated working voltage of AC690V and rated working current of 800A as well as infrequent motor starting. With the overload, short circuit and undervoltage protection functions, the circuit breaker can protect lines and power equipment from damage. Products are widely used in the new energy, power, industrial control, real estate, electric power, telecom, rail transportation, project (public) construction and etc.

2. Picture of the Product



3. Specification and Model Description

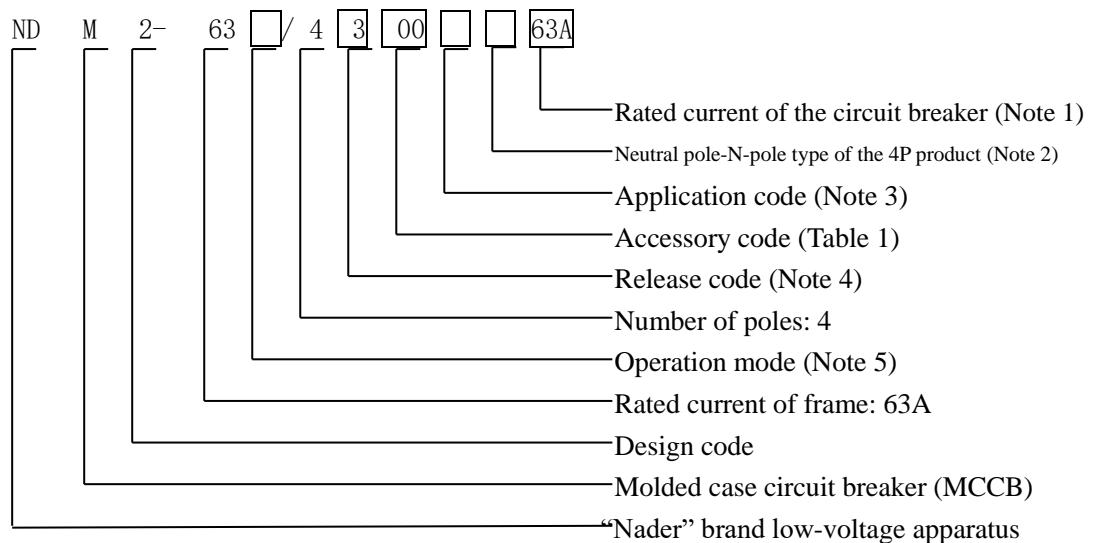

Document No.	NDT500137	Version	1	Implementation date	20111109
--------------	-----------	---------	---	---------------------	----------

Note 1: The rated current is: 10A, 12.5A, 16A, 20A, 25A, 32A, 40A, 50A 63A;

Note 2: The neutral pole-N-pole type of the 4P product is divided into three types:

Type A: The N-pole isn't installed with an overcurrent tripper, but always connected;

Type B: The N-pole isn't installed with an overcurrent tripper, but on-off with the other three poles;

Type C: The N-pole is installed with an overcurrent tripper, and on-off with the other three poles.

Note 3: Application code: No code is available for the circuit breaker for distribution; the protection motor type is represented as 2;

Note 4: Release code;

0: Tripper (none)

2: Instantaneous tripper only

3: Complex tripper





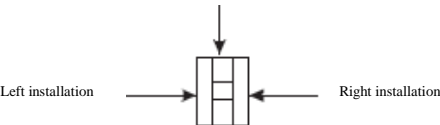

Note 5: No code is available for the direct handle-operated mode; P: Motor-operated; Z: Rotation handle-operated

















Table 1: Comparison Table of Accessory Code:

Handle



Legend

-  Single auxiliary contact
-  Dual-auxiliary contact
-  Alarm contact
-  Shunt release
-  Under-voltage release
-  Auxiliary contact (a single accessory integrates the auxiliary and alarm functions)

Installation position		Model
Accessory code	Accessory name	Number of poles
		NDM2Z-63
		2 3
00	None	—
10	Shunt release	
20	Dual-auxiliary contact	
21	Single auxiliary contact	
30	Under-voltage release	
40	Shunt release, dual-auxiliary contact	
41	Shunt release, single auxiliary contact	
50	Shunt release, under-voltage release	
60	Two sets of dual auxiliary contacts	—
61	Two sets of single auxiliary contacts	
62	Dual-auxiliary contact, single auxiliary contact	
70	Under-voltage release, dual-auxiliary contact	
71	Under-voltage release, single auxiliary contact	
08	Alarm contact	
18	Shunt release, alarm contact	
28	Dual-auxiliary contact, alarm contact	
38	Under-voltage release, alarm contact	—
48	Shunt release, auxiliary alarm contact	
58	Auxiliary alarm contact	
68	Dual-auxiliary contact, auxiliary alarm contact	—
78	Under-voltage release, auxiliary alarm contact	—

Document No.	NDT500137	Version	1	Implementation date	20111109
--------------	-----------	---------	---	---------------------	----------

4、 Main Technical Parameters

Model		NDM2-63		
Rated current of frame Inm (A)		63		
Rated current In (A)		10、12.5、16、20、25、32、40、50、63		
Rated insulation voltage Ui (V)		1000		
Rated impulse withstand voltage Uimp (V)		8000		
Power frequency withstand voltage (1min) (V)		3000		
Usage category		A		
Number of poles		3	3	4
Rated limit short-circuit breaking capacity level		L	M	
Rated limit short-circuit breaking capacity Icu (kA)	AC 400V	25	50	50
	AC 690V			
Rated limit short-circuit breaking capacity level Ics (kA)	AC 400V	19	38	38
	AC 690V			
Operating performance (Number of times)	Electrical life	8000		
	Mechanical life	20000		
Outline dimensions 	L	135	135	135
	W	78	78	103
	H	73.5	81.5	81.5
Flashover distance (mm)		≤50		
Wiring mode		General, P, Z1, Z2Q, Z2H		

Document No.	NDT500137	Version	1	Implementation date	20111109
--------------	-----------	---------	---	---------------------	----------

5、 Connection capacity:

Rated current A	10, 12.5	16, 20	25	32	40, 50	63
Wire cross-section area mm ²	1.5	2.5	4.0	6.0	10	16

SN	Rated current of frame (A)	Thread diameter	Torque value (N)
1	63	M5	4

SN	Rated current of frame (A)	Mounting thread diameter	Torque value (N)
1	63	M3	1

6. Normal Working Environment

- **Operating Ambient Temperature**

-35℃~+70℃; the average within 24 h shall not be more than +35℃. If the temperature is higher than +40℃, the user needs to reduce the capacity. See the "Derating Factor Table of Temperature Change for NDM2Z Series Molded Case Circuit Breakers" for the derating factor.

- **Storage Temperature**

-40℃~+75℃

- **Altitude**

The altitude of the installation site doesn't exceed 2,000m. See the "Derating Factor Table of Temperature Change for NDM2Z Series Molded Case Circuit Breakers" for the derating factor at the altitude;

- **Operating/Storage Relative Humidity**

The relative humidity at an ambient temperature of +40℃ should not exceed 50%. A higher relative humidity is allowed at a lower temperature. For example, the relative humidity at 20℃ can reach 90%. For frost due to temperature change, the corresponding measures should be taken.

- **Pollution Level**

Level 3

- **Installation Category**

The installation category of the circuit breaker connected to the main loop is: III (power distribution and control level);

The installation category of the circuit breaker not connected to the main loop is: II (load level).

- **Installation Environment**

The product should be installed in places that are free from explosive media, media corrosive to metal, insulation damaging gas, and conductive dust, which should be also avoided from snow and rain.

Document No.	NDT500137	Version	1	Implementation date	20111109
--------------	-----------	---------	---	---------------------	----------

● **Derating Factor Table of Temperature Change for NDM2 Series Molded Case Circuit Breaker**

SN	Product model	Derating factor of product temperature change							
		Temperature	40°C	45°C	50°C	55°C	60°C	65°C	70°C
1	NDM2-63	Derating factor	1	0.979	0.958	0.937	0.915	0.893	0.871

High-altitude Derating Factor Table of Molded Case Circuit Breaker

Altitude H Altitude (km)	Rated working current	Ultimate working voltage	Rated working frequency withstand voltage
2	I_n	U_e	U
2.5	I_n	U_e	U
3	$0.98I_n$	$0.83U_e$	$0.89U$
3.5	$0.97 I_n$	$0.77 U_e$	$0.85U$
4	$0.96I_n$	$0.71U_e$	$0.80U$
4.5	$0.95 I_n$	$0.67 U_e$	$0.77U$
5	$0.94I_n$	$0.63U_e$	$0.73U$

7、Tripping Characteristics

NDM2-63 Time/Current Characteristic Curve:

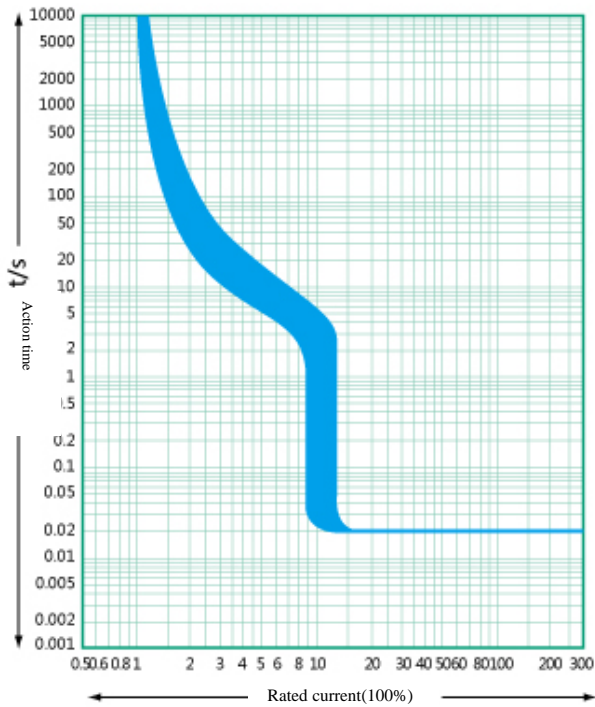

Document No.	NDT500137	Version	1	Implementation date	20111109
--------------	-----------	---------	---	---------------------	----------

8. Outline and Installation Dimensions

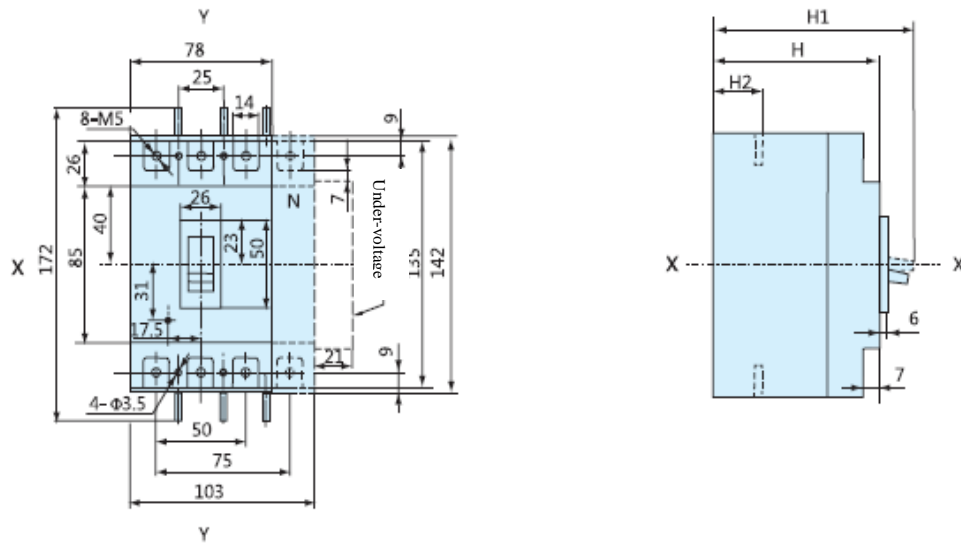

Add a 142" terminal cover (optional); no terminal cover is available for 4P products

Hole Dimensions of Front-plate Connection
Mounting Plate

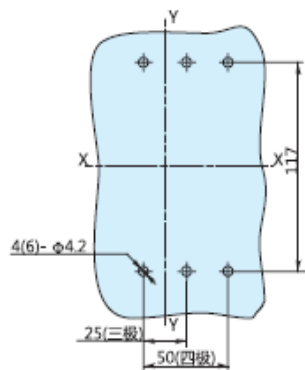

Model	H	H1	H2
NDM2-63L	73.5	90.5	20.5
NDM2-63M	81.5	98.5	28.5
NDM2-63四极			

Document No.	NDT500137	Version	1	Implementation date	20111109
--------------	-----------	---------	---	---------------------	----------

8.1 Insulation distance mounted in the metal cabinet (unit: mm), as shown below:

Mounting distance	A (inlet wire end to the cabinet face)		B (distance from side to cabinet)	C (outlet wire end to the cabinet face)
	With a 0 arcing cover	Without a 0 arcing cover		
Specification				
NDM2-63	25	65	30	30

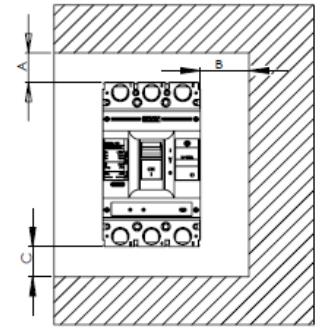

8.2 Minimum center distance between rowed circuit breakers

Specification	Width of circuit breaker (mm)		Center distance (mm)	
	3 poles-3P	4 poles-4P	3 poles-3P	4 poles-4P
NDM2-63	78	103	108	133

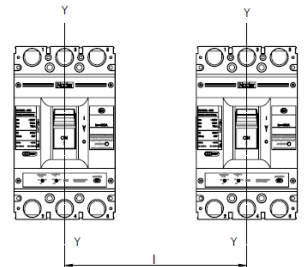

Note: Check the connected busbar or cable during rowing or stacking of the circuit breaker air insulation distance won't be reduced

8.3 Minimum center distance between stacked circuit breakers

Specification	H (distance of circuit breaker from bottom)	
	With a 0 arcing cover	Without a 0 arcing cover
NDM2-63	90	90

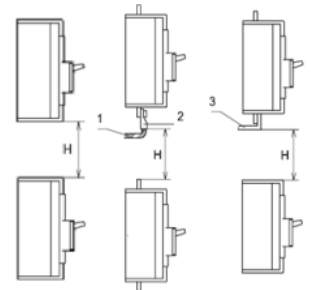

Note:

1. Cable insulating connection
2. Connection without insulation
3. Check whether the 0 arcing cover or phase partition is assembled properly before products are energized.

Document No.	NDT500137	Version	1	Implementation date	20111109
--------------	-----------	---------	---	---------------------	----------

9. Installation Mode

● Installation Direction

- ◆ For vertical installation of the product, the gradient between the installation surface and the vertical plane is no more than $\pm 22.5^\circ$.
- ◆ Horizontal installation of the product

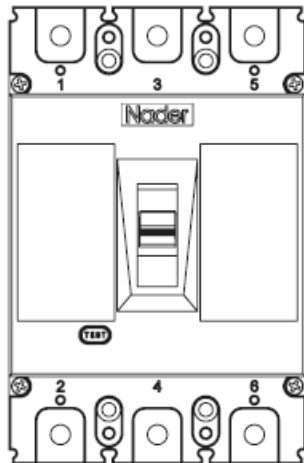

Vertical Installation

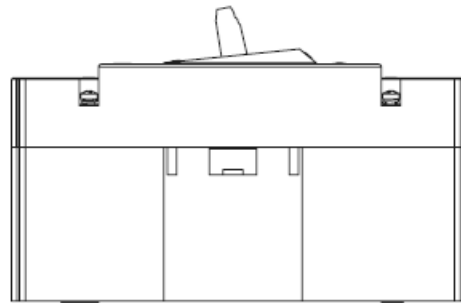

Horizontal Installation

10. Packaging and Storage

Minimum packaging quantity: 1 piece/box. The packaged products should be stored in a warehouse with the ambient temperature of $-45^\circ\text{C}\sim 75^\circ\text{C}$ and the corresponding relative humidity below 80% without acidic, alkali or other corrosive gas in the surrounding air. Under the conditions above, the storage period shall be no more than 36 months since the manufacturing date.

11. List of Accessories and Installation

SN	Name	Specification	Quantity/Set
1	Cross small pan-head screws	M3X35	6
2.	Plain washer	3	6
3	Spring washer	3	6
4	Hexagon nut	M3	6
5	Phase partition	—	6

12. Precautions

▲ Various characteristics and accessories of the circuit breaker are set in the factory, which shall not be adjusted randomly;

▲ The circuit breaker handle can be located in three positions, indicating three states: on, off and free tripping. When the handle is in the free tripping position, pull the handle in the off direction when the circuit breaker is connected and on.

Document No.	NDT500137	Version	1	Implementation date	20111109
--------------	-----------	---------	---	---------------------	----------