

# NDM5-400V/630V Moulded Case Circuit Breaker Product Specification

(IPD-ENG-DEV-T20 A1 2016-09-23)

**Product name: Moulded Case Circuit Breaker (MCCB)**

**Product model: NDM5-400V/630V**

**Date: September 19, 2018**

Prepared by	Xu Tao	Date	September 19, 2018
Reviewed by	Sun Conglin, Zhang Ying	Date	September 19, 2018
Approved by	Gan Feiming	Date	September 19, 2018



1 Applicable scope and purpose

The NDM5-400V/630V series of moulded case circuit breakers have a rated insulation voltage of 1000V and apply to circuits with the AC 50Hz/60Hz, the rated working voltage (AC800V,AC1000V) and rated working current (250A,320A,400A for 400 shell frame, and 400A,500A,630A for 630 shell frame). The circuit breakers are used for distributing power while protect the overload, short circuit and under-voltage (with a under-voltage release) of lines and power units.

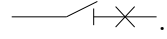
The circuit breaker has an isolating function with the corresponding symbol of .

Comply with standards: IEC 60947-2, GB/T 14048.2.

2 Picture of the Product (See Fig. 1)



Fig. 1

3 Specification and Model Description

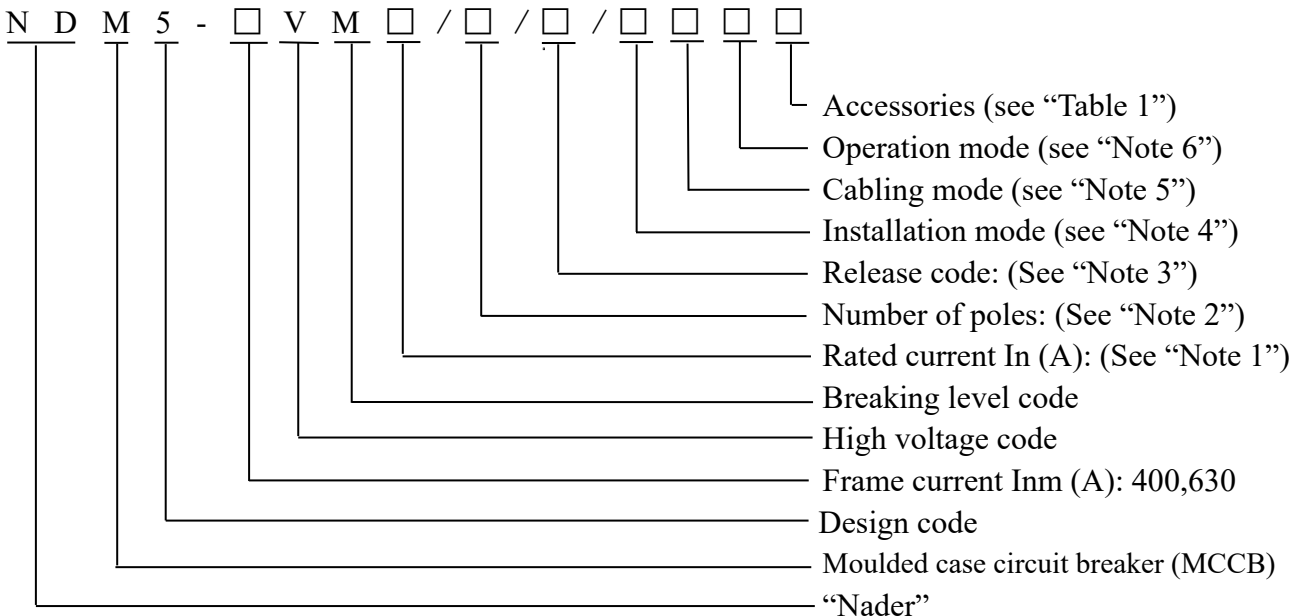

Note: 1) Rated current: NDM5-400V: 250A, 320A, 400A  
 NDM5-630V: 400A, 500A, 630A

2) Number of poles: 3: 3P

3) Release code:

TMF (power distribution protection-thermal magnet-fixed): [Ir=In, Im=10In];

TMD (power distribution protection-thermo-magnetic adjustable): [thermo-adjustable (0.8-0.9-1.0) In,

magnet-adjustable (5-6-7-8-9-10) In, for the distribution];





4) Installation mode: fixed type: no code;

5) Cabling mode: front connection: no code;

6) Operation mode: direct handle-operated: no code; rotation handle operated: "R".

Table 1

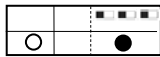
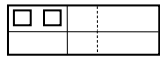
Accessory code	Accessory name	Installation position
00	None	—
08	Alarm contact	
10	Shunt release	
30	Under-voltage release	
21	Single auxiliary contact	
61	Two sets of single auxiliary contacts	
23	Three sets of single auxiliary contacts	
18	Alarm contact+shunt release	
38	Alarm contact+under-voltage release	
22	Alarm contact+single auxiliary contact	
88	Alarm contact+two sets of single auxiliary contacts	
26	Alarm contact+three sets of single auxiliary contacts	
42	Alarm contact+shunt release+single auxiliary contact	
44	Alarm contact+shunt release+two sets of single auxiliary contacts	
46	Alarm contact+shunt release+three sets of single auxiliary contacts	
75	Alarm contact+under-voltage release+single auxiliary contact	
77	Alarm contact+under-voltage release+two sets of single auxiliary contacts	
81	Alarm contact+under-voltage release+three sets of single auxiliary contacts	
41	Shunt release+single auxiliary contact	
11	Shunt release+two sets of single auxiliary contacts	
12	Shunt release+three sets of single auxiliary contacts	
71	Under-voltage release+single auxiliary contact	
72	Under-voltage release+two sets of single auxiliary contacts	
73	Under-voltage release+three sets of single auxiliary contacts	
50	Shunt release+under-voltage release	
31	Alarm contact+shunt release+under-voltage release	

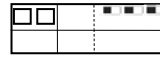
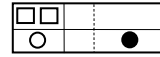
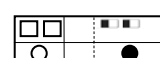
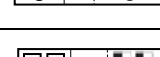
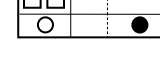
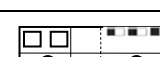
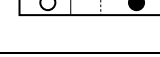
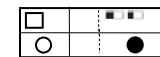
51	Shunt release+under-voltage release+single auxiliary contact	
52	Shunt release+under-voltage release+two sets of single auxiliary contacts	
53	Shunt release+under-voltage release+three sets of single auxiliary contacts	
98	Two sets of single alarm contacts	
63	Two sets of single alarm contacts+single auxiliary contact	
64	Two sets of single alarm contacts+two sets of single auxiliary contacts	
65	Two sets of single alarm contacts+three sets of single auxiliary contacts	
37	Two sets of single alarm contacts+shunt release+under-voltage release	
39	Two sets of single alarm contacts+shunt release+under-voltage release+single auxiliary contact	
55	Two sets of single alarm contacts+shunt release+under-voltage release+two sets of single auxiliary contacts	
56	Two sets of single alarm contacts+shunt release+under-voltage release+three sets of single auxiliary contacts	
32	Shunt release+under-voltage release, single auxiliary contact	
33	Alarm contact+shunt release+under-voltage release+two sets of single auxiliary contacts	
34	Alarm contact+shunt release+under-voltage release+three sets of single auxiliary contacts	

4 Main Technical Parameters

Table 2

Frame current $I_{nm}$ (A)	400	630
Rated current $I_n$ (A)	250, 320, 400	400, 500, 630
Rated voltage $U_e$ (V)	AC800, AC1000	
Utilization category	A	
Rated impulse withstand voltage $U_{imp}$ (V)	8000	
Rated insulation voltage $U_i$ (V)	1000	
Power frequency withstand voltage (1min) (V)	4000	
Rated frequency (Hz)	50/60	
Rated Ultimate breaking capacity $I_{cu}$ (kA)	AC800V	50
	AC1000V	35
Rated Service breaking capacity $I_{cs}$ (kA)	AC800V	50
	AC1000V	18
Mechanical life (times)	15000	
Electrical life (times)	AC800V	1500
	AC1000V	1000

5 Normal Working Environment

- 1) Ambient air temperature:  $-40^{\circ}\text{C}\sim+70^{\circ}\text{C}$ ;
- 2) Storage environment:  $-40^{\circ}\text{C}$  to  $+75^{\circ}\text{C}$ ;
- 3) Altitude:  $\leq 2000\text{m}$ ;
- 4) Class of pollution: 3;
- 5) Protection class: IP20;
- 6) Installation category: main circuit and under-voltage release: installation category III; auxiliary circuit and control circuit: installation category II;
- 7) The product can be disposed in places that are free from explosive media, media corrosive to metal, insulation damaging gas, and conductive dust.
- 8) The product should be installed free from snow and rain.

**Note:** The tripping parameters of circuit breakers are set according to the ambient temperature of  $+50^{\circ}\text{C}$ ; in case of the ambient temperature within  $+50^{\circ}\text{C}\sim+70^{\circ}\text{C}$ , users need to use the equipment for derating capacity. See Table 4 "Derating Factor Table of Product Temperature Change" for the derating factor.

6 Tripping characteristics

6.1 Tripping characteristics curve under normal environment (ambient air temperature:  $50^{\circ}\text{C}$ ), see the picture below:

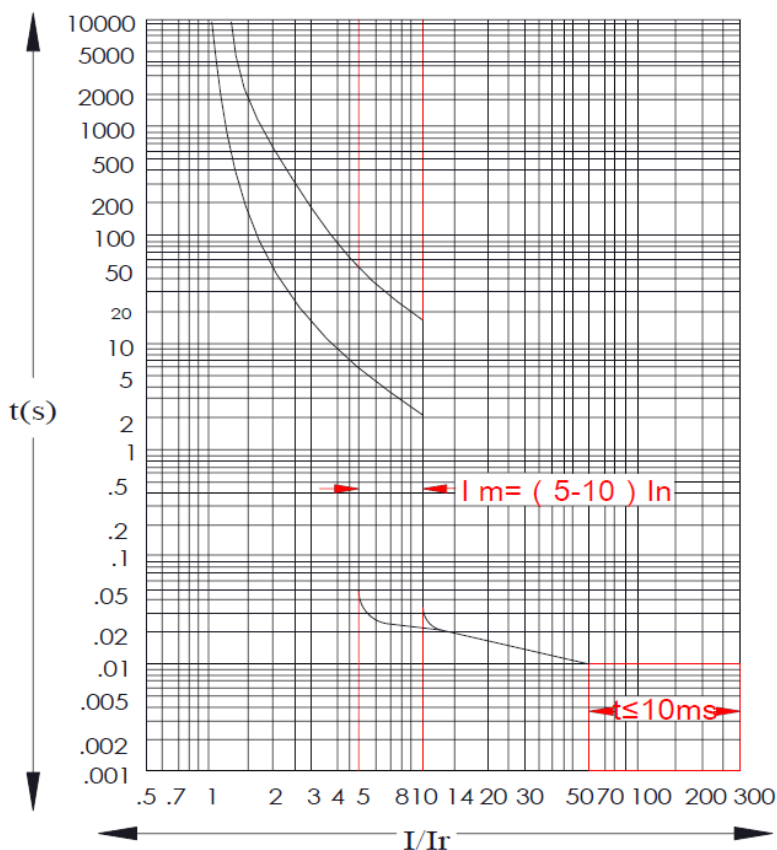

Current limiting curve(AC800V):

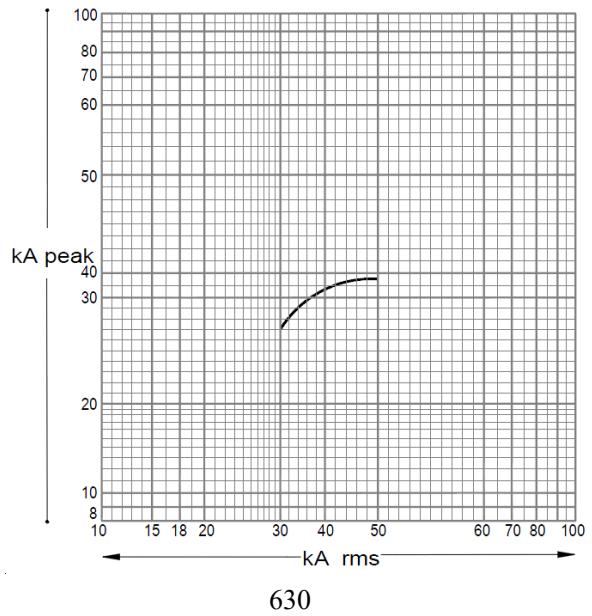
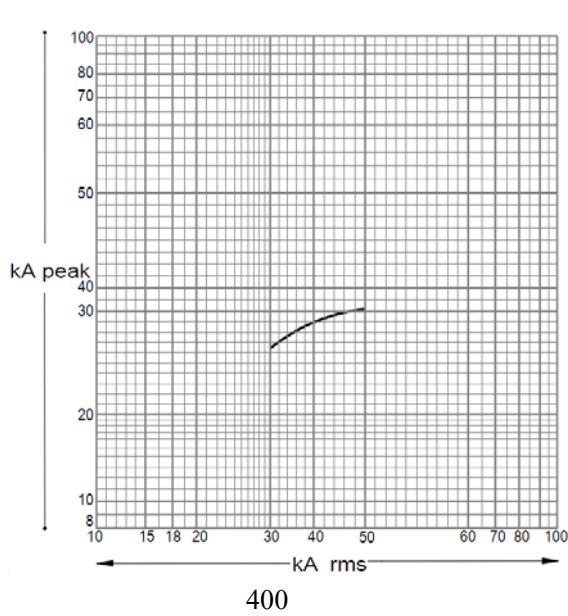

Allowed energy curve(AC800V):

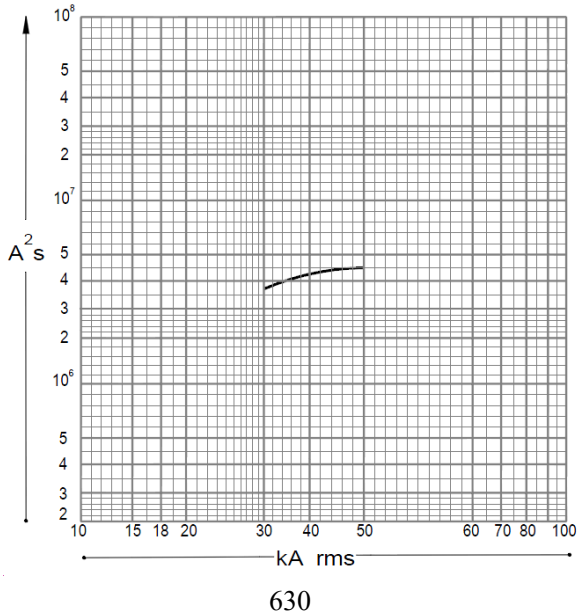
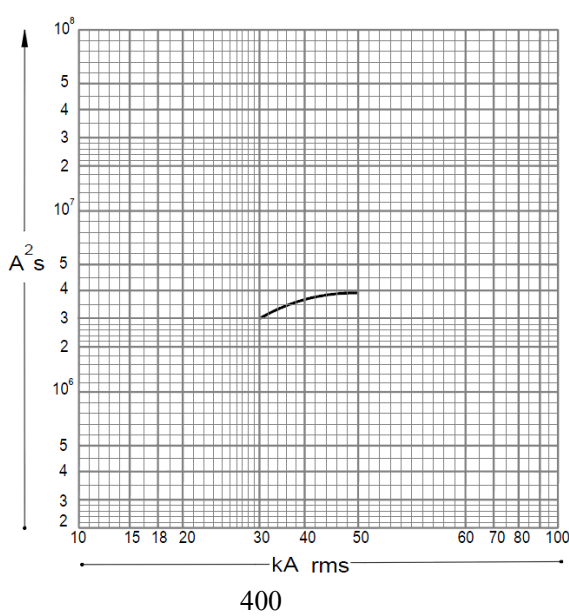

6.2 Parameter setting and function description of the thermo-magnetic adjustable AC distribution release

Table 3

Setting gear of the overload long time-delay $I_r$	0.8 $I_n$ , 0.9 $I_n$ , 1.0 $I_n$
Setting gear of the instantaneous short-circuit $I_m$	5 $I_n$ , 6 $I_n$ , 7 $I_n$ , 8 $I_n$ , 9 $I_n$ , 10 $I_n$ (accuracy of $\pm 20\%$ )
Action time	1.05 $I_n$ (cold state) doesn't operate within 2 hours, 1.3 $I_n$ (thermal state) operate within 2 hours

6.3 The tripping characteristics should be corrected due to small changes when the ambient air temperature varies

Table 4

Ambient air temperature	Correction factor	
	NDM5-400V	NDM5-630V
40°C	1.0	1.0
45°C	1.0	1.0

50℃	1.0	1.0
55℃	0.95	0.94
60℃	0.91	0.90
65℃	0.86	0.85
70℃	0.80	0.80

Note: 1. The above derating factors are measured at the frame current;

2. When the operating ambient temperature is below +50℃, the product can be used normally, without requiring the derating capacity.

6.4 The tripping characteristics should be corrected due to small changes by considering the air insulation characteristics and cooling capacity with the ambient temperature of +50℃ and the altitude above 2,000m (See Table 5)

Table 5

Altitude (m)		2000	3000	4000	5000
Power frequency withstand voltage (v)		4000	3000	2500	2000
Average insulation class (v)		1Ui	1Ui	1Ui	0.95Ui
Maximum working voltage (v)		1Ue	1Ue	1Ue	0.95Ue
Average working current	NDM5-400V	1In	0.96In	0.93In	0.9In
	NDM5-630V	1In	0.94In	0.88In	0.81In

7 Product Outline and Installation Dimensions

7.1 External dimensions of products

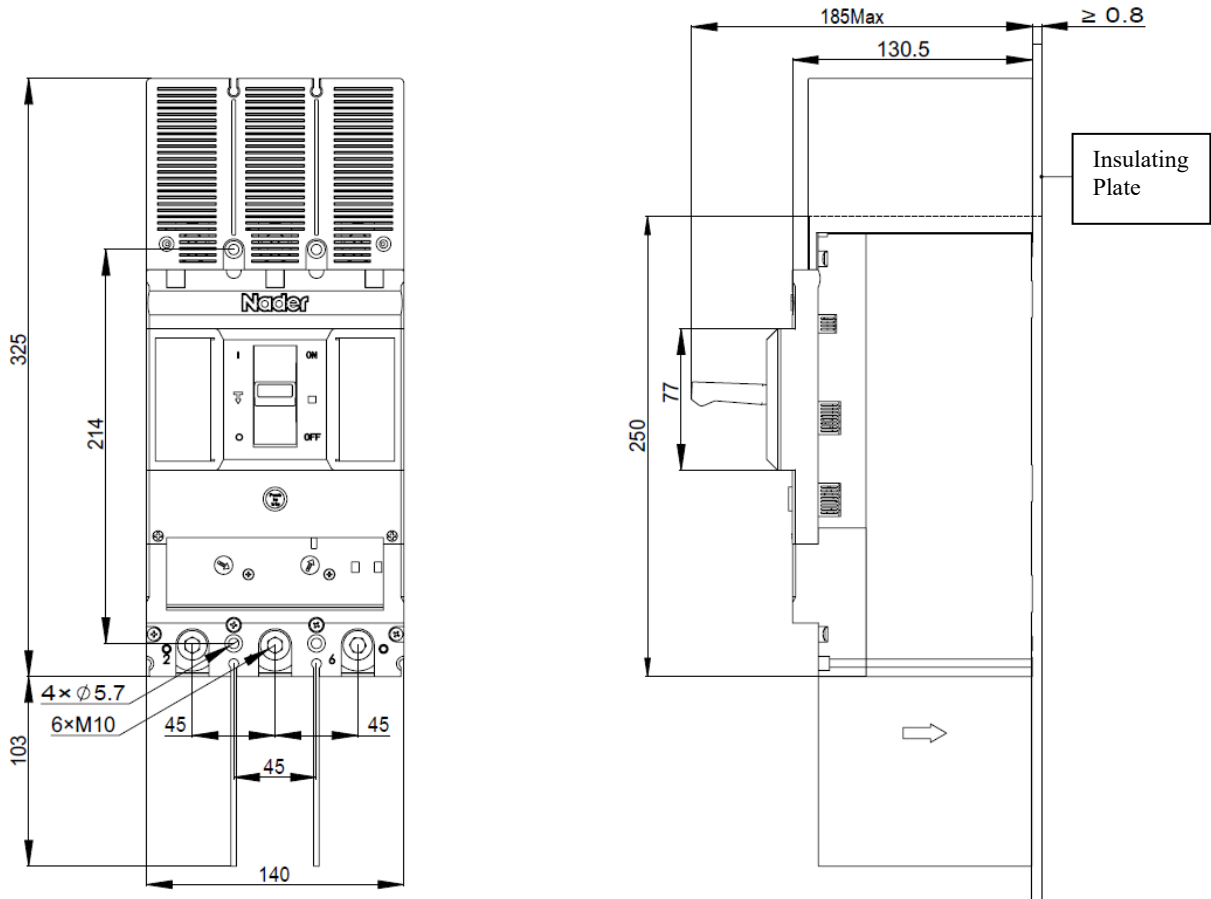

7.2 Product installation dimensions



7.2.1 Installed on the baseplate

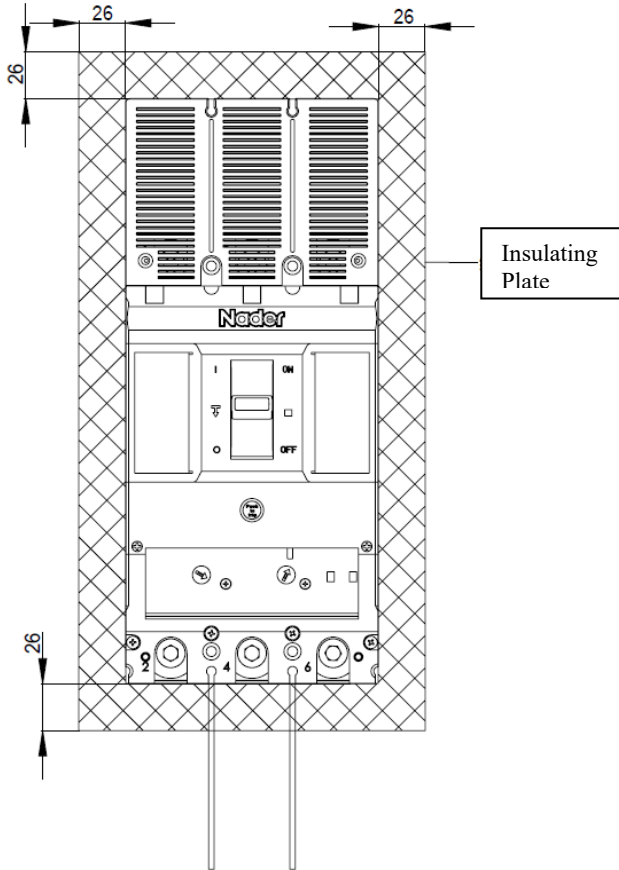

Insulating Plate Dimensions

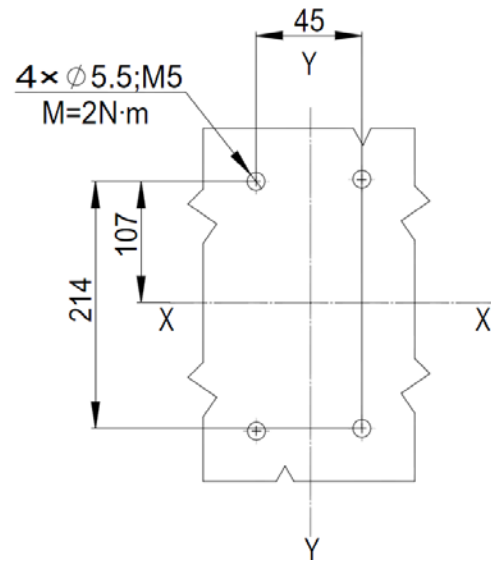

Mounting Hole Dimensions

7.2.2 Safety spacing

See the figure below for the minimum safety distance of the circuit breaker from the top, bottom, side and adjacent products during installation.

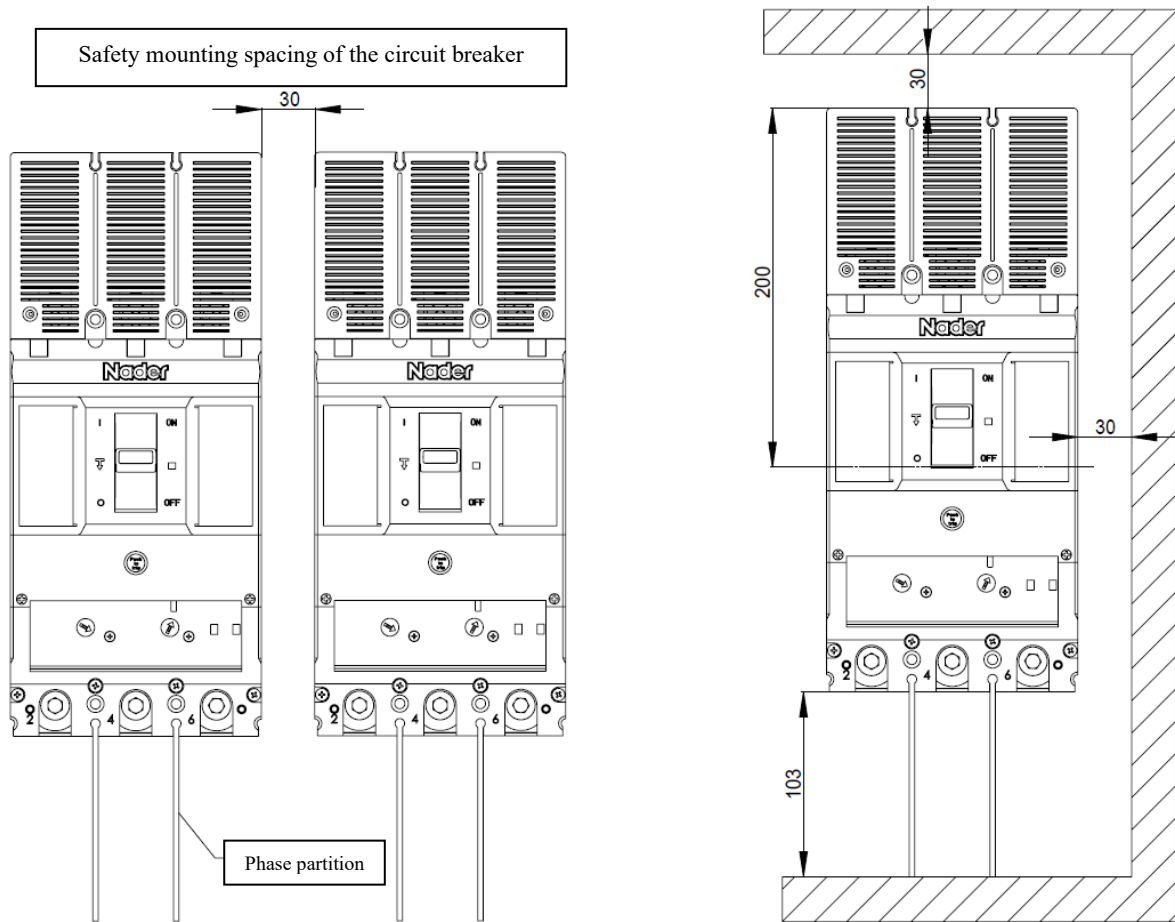

Safety mounting spacing of the circuit breaker

Phase partition

**Notes: During use, a terminal cover and phase partition shall be installed respectively on the terminal side of 1, 3, 5 as well as 2, 4, 6 as shown in the figure. Besides, an insulating plate shall be inserted between the circuit breaker and the metal mounting plate**

8 Installation Mode

The product allowable installation mode is shown as the figure below.

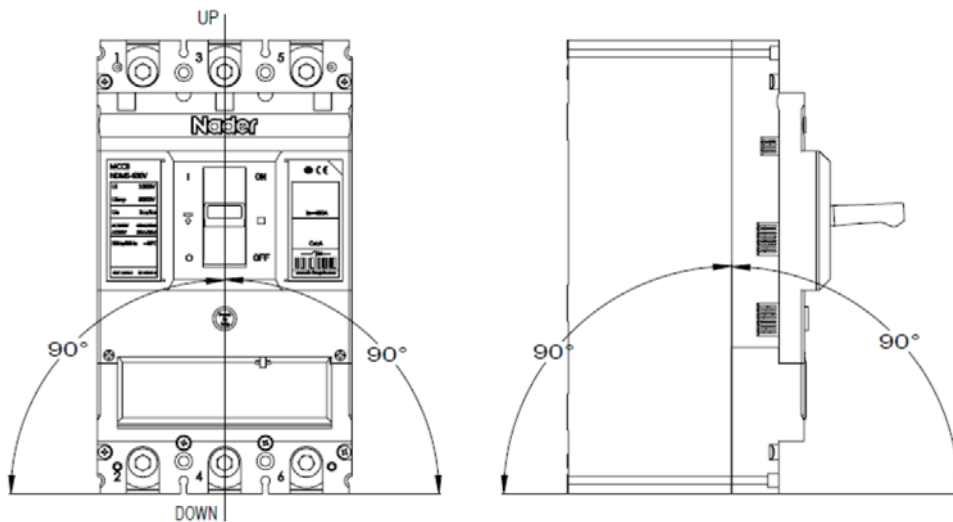

9 Product Power Consumption

Table 6

Product model	Current specifications (A)	Single-phase power
---------------	----------------------------	--------------------

		consumption (W)
NDM5-400V/630V	250	9.4
	320	15.4
	400	19.8
	500	30
	630	39.5
Note: The above data is the single power consumption of the circuit breaker measured at an ambient temperature of 40°C when the rated current is on.		

10 Connection Capacity (See Table 7)

Table 7

Rated current (A)	250	320	400	500	630
Wire cross-section area (mm <sup>2</sup> )	120	185	240	2×150	2×185
Copper bar (quantity×dimensions)	/	/	/	2×30mm×5mm	2×32mm×6mm
Tightening torque of the terminal screw M10	50N·m				

11 Operation Instructions for Accessories

11.1 Rated value of the auxiliary contact (see Table 8, Fig. 2)

Table 8

Accessory	Accessory	Voltage (V)/conventional thermal current (Ith)		
Auxiliary	F1/M5-160	AC250V/10A	AC400V/3A	DC220V/0.2

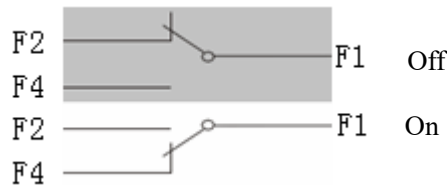

Fig. 2

11.2 Rated value of the alarm contact (see Table 9, Fig. 3)

Table 9

Accessory	Accessory	Voltage (V)/conventional thermal	
Alarm	BJ1-11/M5-160	AC250V/3A	DC220V/0.2A

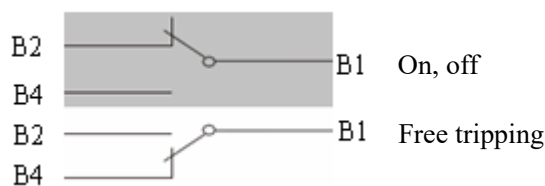

Fig. 3

11.3 Under-voltage release and shunt release

11.3.1 Picture of the product (see Fig. 4)



Fig. 4

11.3.2 Specification and model description (see Table 10)

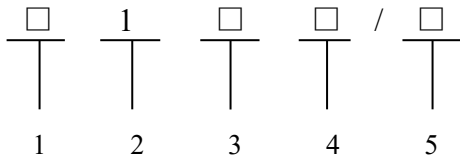

Table 10

SN	SN Description	
1	Function code	FT: Shunt release; Q: Under-voltage release;
2	Design code	1
3	Voltage specifications	Shunt: 02:24V; 23:230V; Under-voltage: 23:230V;
4	Voltage specifications	D: DC; A: AC; T: AC/DC;
5	Body model	NDM5-400/630

11.3.3 Main technical parameters (see Table 11)

Table 11

Product type	Shunt release		Under-voltage release
Product specifications	FT1-02D/M5-400	FT1-23T/M5-400	Q1-22T/M5-400
Rated voltage	DC 24V	AC230V/DC250V	AC230V/DC250V
Instantaneous power consumption	11W	52W	—
Retention power consumption	—	—	2.6W

A. Under-voltage release (see Table 11, Fig. 5)

When the power voltage drops to the rated working voltage range (35%~70%) of the under-voltage release, the release can break the circuit breaker reliably; when the power voltage is 35% lower than the rated working voltage of the under-voltage release, the release can prevent closing of the circuit breaker; when the power voltage is 85% higher than the rated working voltage of the under-voltage release, the release can guarantee reliable closing of the circuit breaker.

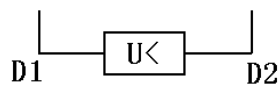

Fig. 5

B. Shunt release (see Table 11, Fig. 6)

When the external voltage of the shunt release is between 70% and 110% of its rated control power voltage, the release can break the circuit breaker reliably.

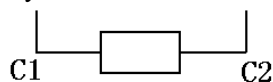

Fig. 6

11.3.4 Normal working environment

- a) Altitude: ≤2000m;
- b) Ambient temperature: -35°C~+70°C;
- c) Pollution level: 3;
- d) Storage environment: -40°C~+75°C;

## 11.3.5 Outline and installation dimensions (see Fig. 7)

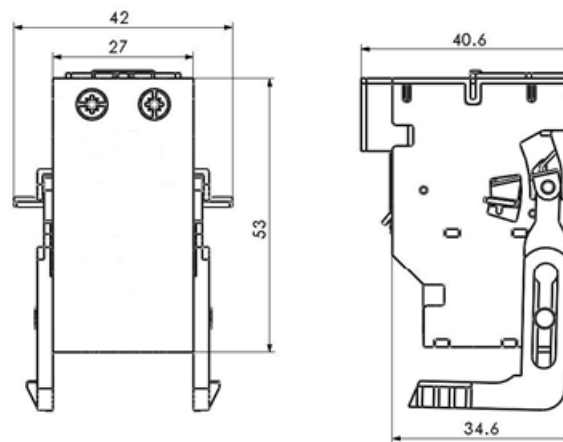

Fig. 7

## 11.3.6 Installation mode

Modular installation of the circuit breaker.

## 11.3.7 Packaging and storage

Products should be stored in a warehouse with the ambient temperature of  $-40^{\circ}\text{C}\sim+75^{\circ}\text{C}$  and the corresponding relative humidity below 80% without acidic, alkali or other corrosive gas in the surrounding air. Under the conditions above, the storage period shall be no more than 36 months since the manufacturing date.

## 11.3.8 Environmental compliance

Comply with the requirements of RoHs directives.

## 11.3.9 Precautions

- This product must be installed by professionally qualified personnel. The product shall not be dismantled without permission of the manufacturer
- Under the energized operation state, be sure not to remove or install the product.

## 12 Packaging and Storage

Packaging quantity: 1 piece/box. The packaged products should be stored in a warehouse with the ambient temperature of  $-40^{\circ}\text{C}\sim+75^{\circ}\text{C}$  and relative humidity below 80% without acidic, alkali or other corrosive gas in the surrounding air. Under the conditions above, the storage period shall be no more than 36 months since the manufacturing date.

## 13 List of accessories and installation (see Table 12)

Table 12

SN	Name	Specification	Quantity/Set
1	Cross small pan-head screw	M5×130	4
2	Plain washer	5	4
3	Spring washer	5	4
4	Hexagon nut	M5	4
5	Phase partition	---	2
6	Insulating partition	---	1

#### 14 Precautions

- a) The performance parameters of this specification are suitable for normal conditions. For special requirements, put the equipment into use after consulting us with formal confirmation and re-adjusting parameters;
- b) The circuit breaker, tripping unit or other accessories can only be installed and maintained by the trained or qualified professionals;
- c) Ensure that the power supply is off before installing or removing any device.